

# SCR-756JY DOBLE CLIC USERGUIDE



SCR756JY-UG-EN-V3.11

## Important Information



Thoroughly review this manual and follow its instructions before installing and operating this device. Keep a copy of this manual for future reference.



**WARNING.** Make sure to carefully follow the safety instructions and guidelines marked with this symbol. Not following them could cause personal injury or property damage.

### ■ Meaning of the symbols used on the product, literature or packaging:

SYMBOL	MEANING
	Read the manual carefully and thoroughly before installing and using the system. Retain this manual for future reference; it contains vital information for the operation and maintenance of your Shipcontroller System.
	The CE mark on the product indicates that the manufacturer has declared conformity with all the essential requirements of European Union legislation regarding safety, electromagnetic compatibility, effectively use of radio spectrum, health, and environmental protection, allowing free circulation and sale within the European market.
	<i>Disposal.</i> The crossed-out wheeled bin symbol indicates that in the European Union, all electrical and electronic products, batteries, and accumulators must be disposed of at specific collection points when they reach the end of their life.
	<i>Safety Warning.</i> This icon indicates the imperative need to follow the accompanying instructions. Ignoring these recommendations may result in damage to people or property.
	<i>Note.</i> This icon highlights important instructions that, if not followed, may lead to improper operation of the equipment.

### ■ CE Declaration of Conformity:



Hereby, Naocontrol SL declares that the Shipcontroller System is in compliance with Directive 2014/53/EU. The full text of the EU declaration of conformity is available at the following internet address:

<https://shipcontroller.com/files/Shipcontroller-RED-DoC-DOC23112901.pdf>

### ■ Manufacturer Information / Contact Information:

Naocontrol, S.L. Félix Acevedo, 1, 6D2 - 15008 A Coruña – SPAIN – VAT ID: ES-B70219274  
 Manufacturer website: [www.naocontrol.com](http://www.naocontrol.com)  
 Product website: [www.shipcontroller.com](http://www.shipcontroller.com)  
 email: [info@shipcontroller.com](mailto:info@shipcontroller.com)

## Table of contents

1 Safety and environmental warnings .....	5
2 System overview .....	6
2.1 Summary of Features.....	6
2.2 Remote unit overview.....	7
2.3 Operation modes.....	8
2.4 Full system overview.....	8
2.5 Device description.....	10
• Status led. Power button. Operation mode button. Bow thruster button-starbrd. Three-axis joystick. Stern thruster button-starbrd. ....	10
• Horn/Menu (+) button. Internal vibrator. (SC) Menu button. Light/Menu(-) button. Stern thruster button-port.....	11
• Bow thruster button-port. Operation mode indicators. Windlass control buttons. Display.....	12
3 Remote control operation .....	13
3.1 General operations.....	13
3.1.1 Power on/off.....	13
3.1.2 Checking system status and radio coverage.....	13
3.1.3 Navigating through menus and screens.....	14
3.1.4 Map of screens and modes.....	15
3.1.5 Operating mode selection.....	16
3.1.6 The <i>Doble Clic</i> feature.....	16
3.1.7 Using the “Horn” and “Light” buttons.....	16
3.2 Docking mode.....	17
3.2.1 Engine Control Menu (Station selection menu).....	17
3.2.2 Maneuver screen.....	18
3.2.3 NAV DATA screen.....	18
3.2.4 DEPTH PLOT screen .....	18
3.2.5 WIND screen .....	19
3.2.6 CHAIN CNTR screen .....	19
3.2.7 WINDLASS screen .....	19
3.3 HOLD mode .....	19
3.3.1 Entering and exiting Hold mode.....	19
3.3.2 Hold Mode operation .....	20
3.4 DPS mode .....	20
3.4.1 DPS activation .....	21
3.4.2 DPS INFO screen .....	21
3.4.3 Reactivation and deactivation of the DPS system .....	22
3.4.4 Exiting DPS mode .....	22
3.4.5 DPS operation notes and tips .....	22
3.5 Autopilot control mode .....	22
3.5.1 AUTOPILOT MODE screen .....	23
3.6 RC mode.....	23

3.7 Using the Joystick to control engines and thrusters.....	24
4. Remote unit settings .....	25
4.1 Entering settings .....	26
4.2 User settings .....	26
4.2.1 Depth alarm .....	26
4.2.2 Thrusters and windlass locking speed.....	26
4.2.3 <i>Doble Clic</i> sensitivity.....	26
4.2.4 Auto screen change.....	26
4.3 System settings .....	27
4.3.1 General settings.....	27
4.3.1.1 Language, Power On Mode, Units, Windlass Memory ....	27
4.3.1.2 Chain calibration.....	27
4.3.2 Thrust settings.....	28
4.3.2.1 PPC: precise pulse control .....	28
4.3.2.2 Engine thrust settings .....	28
4.3.2.3 Thrusters settings .....	30
Bow/Stern thruster settings.....	32
Thrusters balance .....	32
Joystick X-axis thrusters level .....	32
4.3.2.4 Rotation settings .....	33
Default config: rotation thrust, rotation mode .....	33
IPS config: rotation thrust .....	33
4.3.3 Radio settings .....	34
4.3.4 DPS settings .....	35
4.3.4.1 Axis gain and damp settings .....	35
4.3.4.2 Antenna offset settings .....	36
4.4 System Information .....	38
4.4.1 Radio monitor .....	38
4.4.2 Radio information .....	38
4.4.3 System information. ....	38
4.5 Battery charging .....	39
5 Technical Information .....	40
6 Troubleshooting. Warning and error messages .....	41
6.1 Warning messages .....	41
6.2 Error messages .....	41
6.3 Other issues .....	41
7 Maintenance Information .....	42
8 Warranty Information .....	43
APPENDIX I: Release Notes.....	44
NOTES .....	45

# 1 Safety and Environment Warnings





☞ *Carefully read and follow all warnings and instructions in this manual and in the documentation accompanying the product.*

## Shipcontroller Installation

 *The Shipcontroller system must be installed and tuned by trained and authorized technicians, in accordance with the installation instructions provided with each system.*

## Using Shipcontroller

 *Shipcontroller is designed as an steering aid for low speed maneuvers, especially in scenarios such as docking or anchoring. Although it has been developed and manufactured to be very safe and reliable, you should follow good seamanship and safety rules, in particular:*

 *Make sure to follow suitable procedures and to have the adequate crew and resources to maintain control of the vessel and minimize the risk of damaging persons or things.*

 *Turn the system off when not in use.*

## ENVIRONMENTAL WARNINGS

### Restriction of Hazardous Substances (RoHS)

#### RoHS

This system has been designed in accordance with RoHS regulations, which restrict the use of substances harmful to the environment, such as lead, mercury or cadmium.

### Using disposable or rechargeable batteries:



The remote control unit is designed to use rechargeable batteries. Batteries must be disposed of according to current regulations, placing them in a suitable container.

### Product Disposal:



When you decide to discard this product, for example, at the end of its life cycle, do it according to the ordinances or regulations governing the disposal of electronics devices.



---

## 2 System Overview

### 2.1 Summary of Features

The remote control unit model SCR756JY provides the following capabilities or features, inherited from its predecessor, model SCR755J:

- A robust joystick with three-axis control and IP67-rated protection
- A bidirectional radio data link with 128-bit encryption.
- The NET microcode option, which allows the deployment of a network of up to 8 radio transponders and the use of up to 4 remotes with concurrency control. This results in a high availability, fault tolerant radio data system.
- A sunlight readable hybrid e-ink display.
- Data telemetry, including: boat speed, course, depth, wind speed and direction, chain count.
- Stepped or proportional control for two engines.
- Stepped or proportional control for two thrusters.
- Control buttons for up to two anchor windlasses.
- Control buttons for two auxiliary control channels (Horn, light).
- Optional remote control of a compatible autopilot.
- Menu commands to reset the chain counter, activate the control head, etc.
- Depth Alarm: it raises an alarm if the depth is less than the configured value.
- Thruster inhibition: it disables the thrusters if the boat's speed is greater than the set speed limit.
- Rechargeable internal Lithium-Polymer battery.
- IP65 watertight.

In addition, the SCR756JY remote adds new features, such as:

- A **new engine control algorithm**, which makes maneuvering with the joystick much easier.
- The ***Doble Clic*** feature allows a button or lever to perform different actions by successive presses. This allows us, for example, to obtain different levels of thrust from the engines or thrusters using a simple control lever.
- The thrusters **Hold mode** allows both thrusters to be activated at the same time with a simple maneuver, providing only the bare minimum thrust necessary keep the boat “glued” to the dock. This mode is only available in case of proportional or PPC thrusters.
- The **Precise Pulse Control (PPC)** technology allows for a reduction in the average thrust of the engines and/or thrusters. It is useful, for example, to ensure that the boat does not increase its speed too much if the thrust of the engines geared to idle is excessive.
- Control of the Shipcontroller **Dynamic Positioning System** module (DPS), which allows us to maintain the position and heading of the ship within narrow margins of error.
- A new organization of menus and screens, structured under the “**operation mode**” concept, which allows the remote to be a true multifunction system. (See “operating modes”).
- The new **RC mode**, which facilitates the control of remote control modules such as the engine start/stop module, the relay expansion unit, or other modules that can be incorporated later.

The SCR756JY remote unit can be configured to work with certain configurations of electronic controls. At this moment there are two possible configurations:

- **The default configuration.** It is called 756JY-SW. This configuration is suitable for the vast majority of engines and electronic engine control systems on the market.
- **IPS configuration.** It is called 756JY-IPS. It is a special configuration that enables interoperability with the engine control of boats that have an IPS system controlled by a Joystick.

***Most screens and menus are common to both configurations. When this is not the case, it will be indicated in this manual as follows: “SCR756JY-SW model only”, or “SCR756JY-IPS model only”.***

## 2.2 Remote unit overview

The figure below shows the main elements of the remote control unit:



## 2.3 Operation modes

The SCRT756JY remote unit implements the new "operation modes" structure, which allows the remote to be a true multi-function control system.

The current firmware version supports the following modes:

OPRTN MODE	
<b>DOCKING</b>	
HOLD	DPS
AUTOPILOT	RC
SETTINGS	
SEL	> Esc

- Docking mode:
  - This mode of operation is intended to help in performing the berthing or anchoring maneuvers.
  - It includes the following screens:
    - Maneuver screen, which shows the status of the propellers.
    - Navigation data screen.
    - Chain counter screen / Windlass selection.
    - Wind data.
    - Engine control activation.
- Hold mode:
  - The Hold mode allows you to engage both thrusters at low speed, with the flick of a lever, to "hold" the boat close to the dock.
- DPS mode:
  - With this mode you can enable/disable and control the status of the (optional) dynamic positioning module.
- Autopilot mode:
  - This mode of operation converts the remote into a wireless controller that can operate a (compatible) autopilot.
- RC (Remote control) mode:
  - This operating mode allows access to specific screens to control special expansion modules. For example, a module to start/stop the engines, or a control module for a crane or walkway.

## 2.4 System overview

The schematic on the next page shows, as an example, a complete Shipcontroller system. As it is a modular system, it is easy to add new functionalities through modules that can be connected to the Shipcontroller canbus.

The schematic shows a Shipcontroller NET system, including a network of radio transponders to provide secure and redundant radio coverage on super vessels or metal hulls. It also allows you to use several remotes, even of different models. These are some of the modules that may be found in a typical Shipcontroller system:

- The SMCU module provides the communications interface (NMEA2000, Seataalk, NMEA0183) for navigation data telemetry, as well as chain counter functions and relay outputs for windlasses, on/off thrusters, horn and lights control.
- The RFU radio transponder handles communications with the remotes. There can be at least one unit, but we can deploy up to 8 RFU modules.
- The engine interface module is responsible for engine control. There are specific versions supporting most engine control systems on the market.
- The proportional thruster interface allows Shipcontroller to interact with thrusters that feature the proportional control mode.
- The DPS system helps to keep the ship's position and heading within its operating margins and margins of error.
- The autopilot interface makes it possible to control the activation, deactivation and course adjustments of a –compatible- autopilot.
- The family of RC modules is meant to expand the control capabilities of the system, for instance, controlling gateways, turning on/off lights, starting/stopping engines, and so on.
- *New expansion modules will be incorporated in the future.*





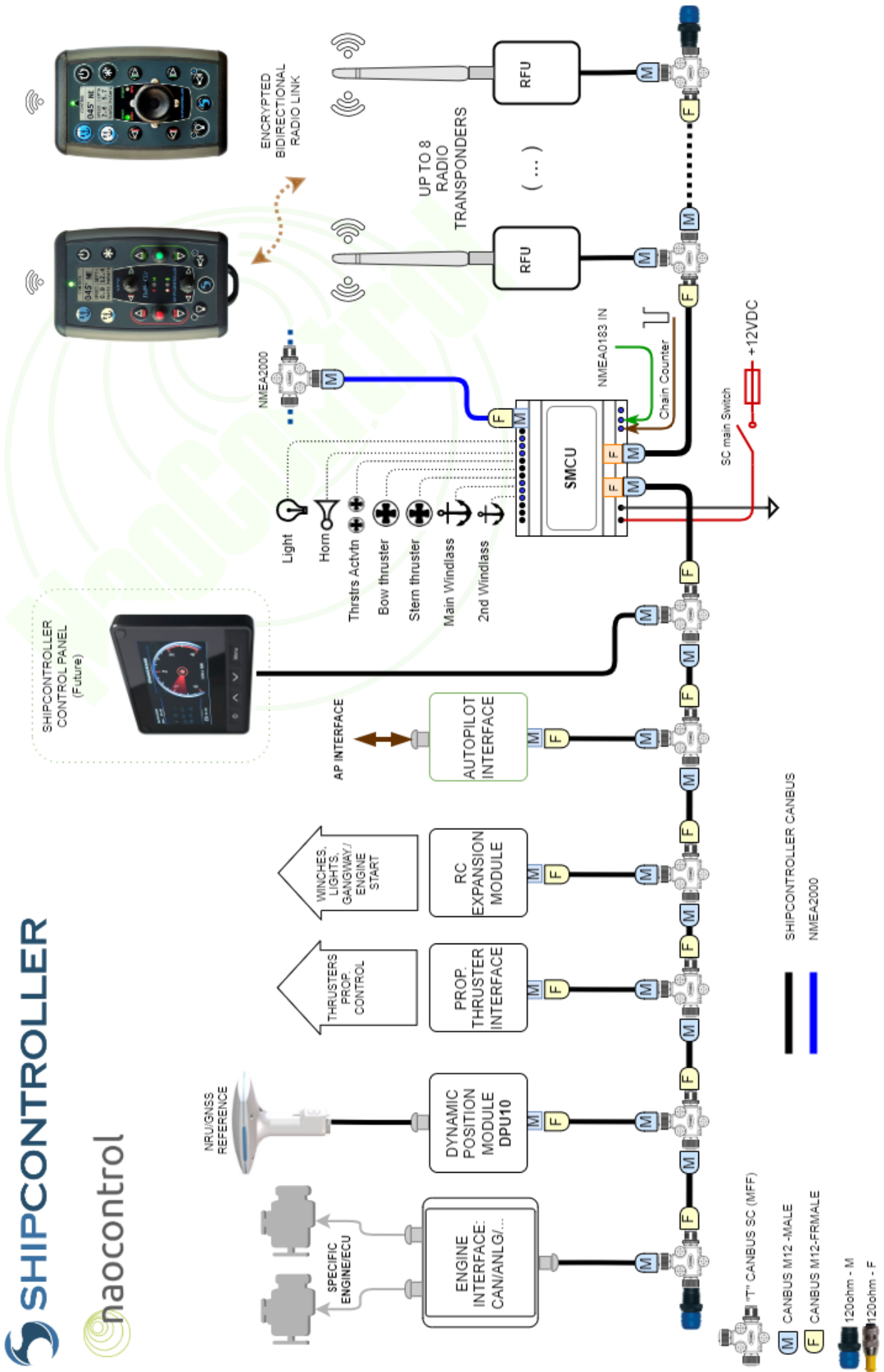









# SHIPCONTROLLER



## 2.5 Device description

### 2.5.1 Led Status indicator

The status bicolor LED provides system status information.

Green	Red	Meaning
 On	 Off	Wireless data link established and operative. Base system operative. Engine controls ready.
 Blinking 1/sec.	 Off	Wireless data link established and operative. Base system operative. Engine control NOT available.
 Blinking 10/sec.	 Off	Some control button has been activated, and the remote is trying to send user commands to the base transceiver.
 Off	 On	No radio coverage / The base system is powered off.
(On or Off)	 Blinking 1/sec.	Low battery level.
 Blinking 5/sec.	 Blinking 5/sec.	Waiting for a press of the [SC] button after switching on the remote in safe mode (two phases start mode).
 Blinking 1/sec.	 Blinking 1/sec.	Remote unit failure.

### 2.5.2 Power button

This button allows you to turn the remote control unit on and off, and to display the boat's name and other information.



### 2.5.3 Operation mode button

This button allows you to select the operation mode of the remote. Pressing it briefly will activate the operation mode selection screen. Consult the section 3.1.5 for more information



### 2.5.4 Bow thruster button-starboard

Pressing this button will activate the bow thruster to make the bow go to starboard. Thanks to the "Doble Clic" feature, this button can be used to select between two different levels of thrust.

### 2.5.5 Three-axis Joystick

The three-axis Joystick allows you to move freely along the x and y axes, and can be rotated around the Z axis. It allows you to perform various maneuvers with the engines and/or thrusters, depending on the configuration of the boat's propulsion.

### 2.5.6 Stern thruster button - Starboard

Pressing this button will activate the stern thruster to make the stern go to starboard. Thanks to the "Doble Clic" feature, this button can be used to select between two different levels of thrust.

## 2.5.7 Horn/ Menu (+) button

The button with a horn icon is a multi-function button. Depending on the context, it can act as:



- A pushbutton intended to activate a horn. This is the default function.
- A pushbutton that selects a menu option, to enter a positive response (yes), or to increase a value (+).

## 2.5.8 Internal vibrator

The remote unit includes an internal vibrating device which is used to indicate warnings, such as:

Vibration signal	Meaning
One short pulse	* Initial self-test completed. * Engine control restored.
Continuous, while activating any engine control on the remote	* No radio coverage. * Unregistered remote (in multi-remote systems). * No engine control.
Continuous, while activating any thruster control on the remote	* No radio coverage. * The Thruster inhibition feature is active and the speed is too high.
Two short pulses	Power off sequence completed.
Two long pulses	* Engine control lost.
Three long pulses	* Depth alarm warning.

## 2.5.9 (SC) Menu Button

This pushbutton allows the user to navigate through the different screens, and access the menu options. This button recognizes both a short and a long press.



## 2.5.10 Battery charge indicator

This led indicator will light up when the remote control unit is placed over a powered Qi wireless charger. The possible states of this indicator are as follows:

- Off: charging adapter disconnected or turned off.
- Red: battery charging.
- Green or blue: charging completed.

## 2.5.11 Light/Menu (-) button

The button with a bulb icon is a multi-function button. Depending on the context, it can act as:



- A button that activates a light. This is the default function.
- A button intended to increase or decrease a value (-).

## 2.5.12 Stern thruster button - Port

Pressing this button will activate the stern thruster to make the stern go to port. Thanks to the "Doble Clic" feature, this button can select between two different levels of thrust.

### 2.5.13 Bow thruster button - Port

Pressing this button will activate the bow thruster to make the bow go to port. Thanks to the "Doble Clic" feature, this button can select between two different levels of thrust.

### 2.5.14 Operation mode indicators

They are a pair of green/red LED indicators that signal the operation mode of the Shipcontroller system, as follows:

- DOCK / HIGH indicator
  - Green: Docking mode activated.
  - Red: "HIGH" mode activated. (Only IPS mode).
- STEER / DPS indicator
  - Green: "STEERING" or AUTOPILOT mode activated.
  - Red: "DPS" (Dynamic Positioning) mode activated.

During the remote unit boot sequence in safe mode, both indicator lights, as well as the status indicator, flash red.

### 2.5.15

### 2.5.16 Windlass control buttons



The remote allows you to control up to two independent windlasses. The main windlass is associated with the chain counter function. If the auto change display function is enabled, the display will switch to chain counter mode when any of these buttons is pressed, and return to the previous display after a short delay.

- The down arrow button allows you to lower the selected anchor.
- The up arrow button allows you to lift the selected anchor.

### 2.5.20 Display

The remote control features a graphic display that employs hybrid electronic ink technology. It is readable in full sunlight and in very low light conditions. Its power consumption is very low, which allows a long life of the remote's rechargeable battery.

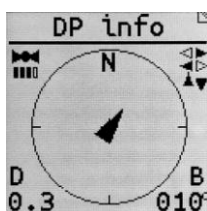

## 3 Remote control operation

The remote control unit features arrows and other symbols on or next to the buttons and control levers which make it easier to associate their position with their effect on the boat. *Many users choose to direct the remote control unit to always match the orientation of the vessel for easier use.*



### 3.1 General operations

#### 3.1.1 Power on/off



##### Power on:

In order to turn on the unit, press briefly and release the power button. If you keep the power button pressed, the display will show custom information, usually: boat name, harbor and battery charge level.

##### Two-phase start procedure:

For greater security, the system can be configured for a two-phase boot. After pressing the power button, the user will have to press the menu button, as indicated on the screen. If this procedure is not completed in a few seconds, the system will turn itself off.



##### Power off:

In order to turn off the remote unit, press the Power Button until the power off screen is shown. The remote will produce two short vibrations.

##### Auto power-off function:

The unit will power off by itself after 30 seconds of inactivity when there is no radio coverage. That is, if you turn off the base system, the remote will automatically shut down after 30 seconds without using it.

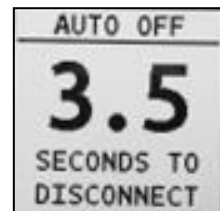

The system will also turn itself off if the two-phase start procedure fails, or if there is a serious fault.

#### 3.1.2 Checking the system status and radio coverage

Once the remote unit has been started, and while the remote is in use, the user must pay attention to the red and green lights, and also to the vibration signals. Please read sections 2.5.1 and 2.5.10 for a full description of warning signals.



The loss or interruption of the radio link (due to remote or base switching off, due to loss of coverage, breakdown, or other cause) implies that:

- *None of the remote control or telemetry functions will be available.*
- *All the controlled systems will be immediately restored to their neutral/idle position.*
- *You must immediately regain control of the ship.*



### 3.1.3 Navigating through menus and screens



There are four types of elements in the remote:

- Indicators:
  - The graphic display, the status leds, and the internal vibrator.
- Maneuver controls, intended to directly manage the boat's systems:
  - Engines and thrusters control levers or buttons.
  - Windlass control buttons.
- Remote operation buttons:
  - On-Off button
  - Operation mode button.
  - The (SC) button.
- Multifunction buttons: Horn and Light buttons:
  - They can operate as maneuver buttons or as menu buttons, depending on the context.
  - The Function/Menu indicator will show the current operation mode for those buttons. (See section 2.1.6).

The information displayed on the remote screen may change for any of these reasons:

- In response to a change in the mode of operation.
- In response to pressing the SC key, or pressing the Menu +/- (Horn/Light) keys.
- In response to some maneuver, when the "automatic screen change" option is activated.
- By signaling an alarm or pop-up message.

The following sections explain how to change from one screen to another and access the different menus, and how to use the operation/menu buttons:

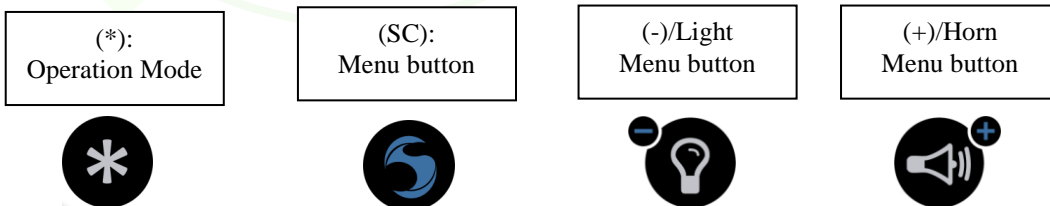

#### Secondary screens:



Some screens have a symbol on the upper right corner to indicate that they have a secondary action screen.

To access the secondary action screen, **push and hold the (SC) button** until the secondary screen appears.

### 3.1.4 Map of screens and modes

The diagram below shows, schematically, the flow of menus and screens. For a flowchart of settings screens and menus, see the settings section.

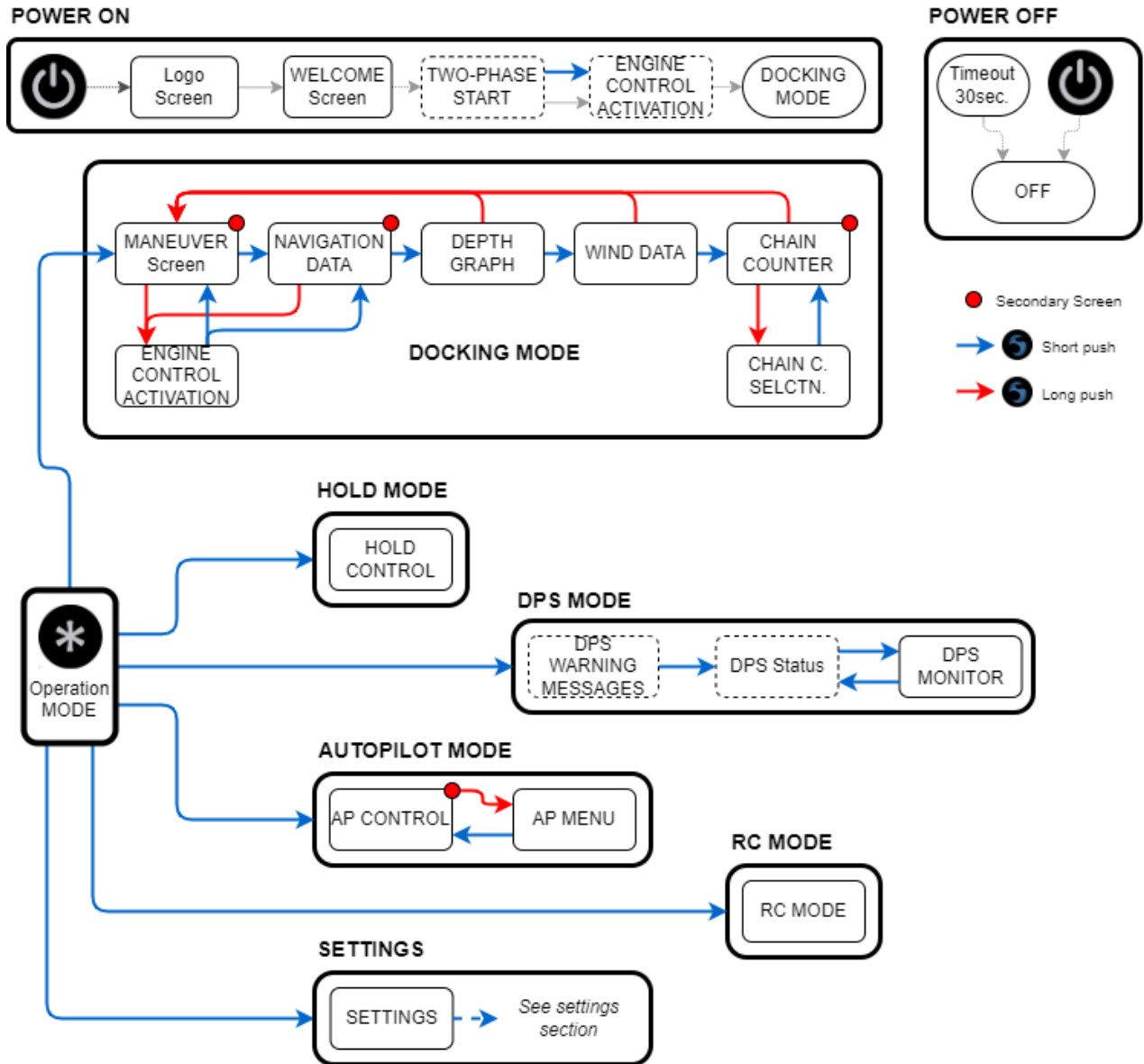

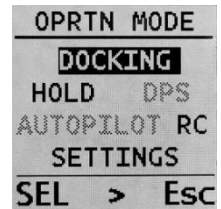

### 3.1.5 Operating mode selection

The mode selection screen is activated by pressing the (\*) button. If any of the modes is not available, the mode is grayed out. When the remote is started, it enters the Docking mode by default. To change the mode of operation:



1. Briefly press the (\*) button. 
2. The screen will change to show the list of possible options. If any of the modes is not available, the option will be grayed out, and we will not be able to select it. These menu options will appear on the bottom line of the screen:



- (SEL) to change the selected mode. 
  - (>) to activate the chosen mode. 
  - (Esc) to exit the operating mode screen and return to the previous screen. 
3. You can change the selected mode in two ways:
    - By briefly pressing the (\*) button.
    - By pressing the SEL button.
  4. To activate the selected mode, you can also do it in two ways:
    - By pressing and holding the (\*) button until the mode changes.
    - By briefly pressing the (>) button.

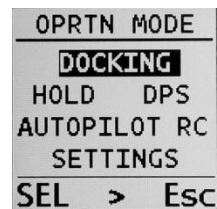

The operation mode selection screen will disappear:

- Automatically after 2 seconds, if no key has been pressed.
- When activating a mode.
- By pressing the Esc key

### 3.1.6 The *Doble Clic* Feature

On/off buttons and normal levers usually allow for simple operation only. In case of toggle-type levers, such as those used in this remote, we have three positions: a central one, and one on each side of it.

The exclusive *Doble Clic* function adds an extra control operation, which is activated by "double clicking" the corresponding lever. So we can, for example, have two additional levels of thrust for the thrusters or engines.

Furthermore, with this remote, the thrust levels of proportional thrusters can be adjusted very easily from the remote control menus.

- Push the lever or button normally. It will activate the first level of thrust.
- Release and quickly activate the lever (or button) again, in the same direction: it will activate the second level of thrust.
- If you want to return to the first level of thrust, release the lever, wait a short time, and press it again.
- If you release the lever at any time, the maneuver will go to neutral immediately.

This feature is available for thrusters and engine levers. In order to have different levels of thrust it is necessary that the thrusters or engines accept proportional or step control from the Shipcontroller system.

### 3.1.7 Using the "Horn" and "Light" buttons



As stated in section 2, these buttons serve two purposes:

- As menu buttons, to select the actions indicated on the screen. In this case, the menu mode led indicator will be on. (Section 2.5.16).
- To activate the horn or the deck Lights. In this case, the menu mode indicator led will be off.

- The "Horn" function works as a temporary button, that is, the horn will sound as long as we keep this button pressed.
- On the other hand, the "Light" function works like a toggle switch: each time we press it, the function will change its state, from on to off or vice versa.

## 3.2 Docking Mode

Docking mode includes essential monitoring and control functions to help make docking or anchoring maneuvers easy. This mode includes:

- The Station Selection Menu (Engine Control Activation).
- The MANEUVER screen, which shows the control status of engines and thrusters.
- The NAV DATA screen, which shows the current heading, depth and speed.
- The DEPTH screen, showing a depth graph.
- The wind screen, showing the apparent wind data.
- The chain counter screen.
- The windlass selection and chain count reset menu.

In this mode, essential controls will be active, such as:

- Engine control.
- Thruster control.
- Control of the main and secondary windlasses.
- Horn and Light control. (Except for the menu screens).

If the speed lock feature for thrusters and windlasses is on, and the boat exceeds the set speed, the thrusters and windlass will be locked, and an error message will be displayed on the screen if you try to use them.

### 3.2.1 ENGINE CTRL menu (Station selection menu)

#### a) Default configuration:

Some engine control system configurations require the Shipcontroller to acquire engine control, as if it were just another station in the electronic engine control system.

In these cases, it is possible for the remote not to have engine control when you turn it on. If so, the green led will be blinking slowly, and if you try to use the engine controls, you will get a vibration from the remote and an error message on the screen.

If no engine control is available when starting the remote, the engine control enable screen will appear automatically.

This screen also shows the port and starboard engine control status.

- Press the (Act) button to request engine control for the Shipcontroller remote.
- Press (>) or (Esc) to exit this screen and return to the previous screen.

If the engine control is activated when starting the remote, the green led will be on, and this screen will not be displayed.

You can also access this screen from the MANEUVER or DOCKING screens by pressing and holding the (SC) button.

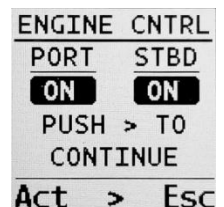
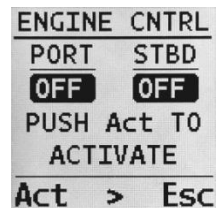

**b) IPS configuration:**

When the remote has been configured for IPS, the remote unit's joystick will behave similarly to the ship's joystick. The engine control menu will show options equivalent to those found on the Ship's joystick.

- Press the (SEL) button to change the selected item.
- Press the (REQ) button to transmit a selected mode activation request.
- Press the (>) button to exit this screen and return to the previous screen.

If the selected option is activated, it will be displayed on a black background.

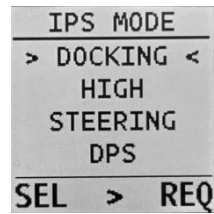

**3.2.2 MANEUVER screen**

**a) Default configuration:**

The purpose of this screen is to show the direction and amount of thrust of the thrusters and engines when the remote is used.

If the "Auto screen change" setting has been activated, this screen will appear whenever you operate a thruster or engine control, and it will return to the previous screen after 0.5 sec.

- Press and hold the (SC) button to access the ENG CNTRL action screen.
- Press the (SC) button briefly to access the next screen.

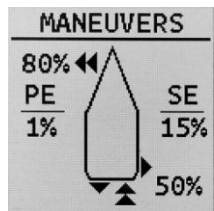

**b) IPS configuration:**

In case of IPS configuration, this screen will show the position of the joystick on the X and Y axes and the rotational thrust.

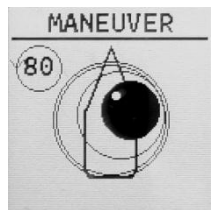

**3.2.3 NAV DATA screen**

If navigation data are available, this screen will show:

- COG (Course Over Ground) in degrees, and the matching direction of the compass rose.
- SOG (Speed Over Ground) in knots.
- Depth in meters.
- Press and hold the (SC) button to access the ENG CNTRL action screen.
- Press the (SC) button briefly to access the next screen.

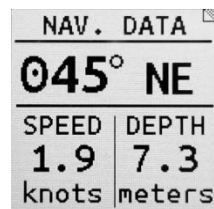

**3.2.4 DEPTH PLOT screen**

This screen shows a graph with the latest 48 depth values. The history of depth measurements is updated every second.

The scale of the vertical axis is automatic; it will change depending on the maximum and minimum depth values displayed.

If the depth alarm is active, the display will show a warning message.

- Press and hold the (SC) button to access the NAV DATA screen.
- Press the (SC) button briefly to access the next screen.

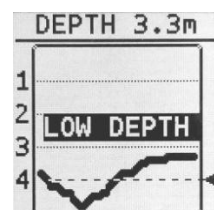
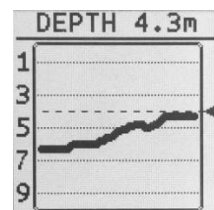



### 3.2.5 WIND screen

If wind data are available, this screen will show:

- Apparent wind angle, from -180.0 to +180.0 (degrees).
  - Apparent wind speed (knots).
- Press and hold the (SC) button to access the NAV DATA screen.  
 ➤ Press the (SC) button briefly to access the next screen.



### 3.2.6 CHAIN CNTR screen

If data are available, this screen will show:

- The chain count value (meters).
- The water depth value (meters).
- The chain count/depth ratio.

If the secondary windlass is selected, no chain count data will be shown. (The chain counter function is associated only with the main windlass).

- Press (SC) briefly to access the next screen.  
 ➤ Press and hold (SC) to access the secondary screen, WINDLASS.

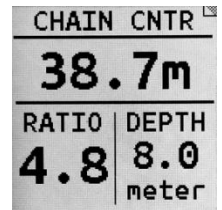

### 3.2.7 WINDLASS screen

This screen allows you to reset the chain count value and to select the windlass you want to control/operate.

- Press SEL (-) to select the windlass.  
 ➤ Press RST (+) to reset the chain count value.  
 ➤ Press (SC) to return to the CHAIN CNTR screen.

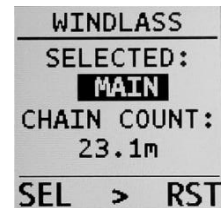

If the "Windlass memory" setting is activated (see section 4.3.1), the remote will remember the latest selected windlass even if you turn the remote off and back on again.

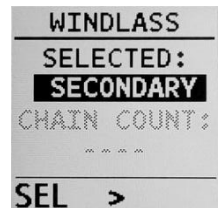

## 3.3 Hold mode

The Hold function allows you to activate the bow thruster and stern thruster at the same time, to the same side, simply by pushing one of the thruster control levers.

HOLD mode will only be available if both the bow and stern thrusters have been set to proportional or PPC mode.

### 3.3.1 Entering and exiting Hold mode

To enter Hold mode, follow the mode selection instructions included in the 3.1.5 section; in summary:

- Press the (\*) button to activate the operating mode selection screen.
- Press (\*) or (SEL) to select Hold mode.
- Hold down (\*) or briefly press the (SC) button.

To exit Hold mode, simply press the (SC) button. You will return to Docking mode.

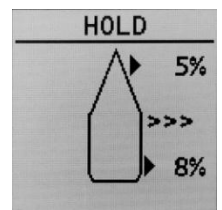

### 3.3.2 Hold mode operation

This function is ideal for use with proportional thrusters, since we can activate both thrusters with a small push, and adjust the thrust of each thruster from the remote, as appropriate.

- Activate both thrusters to one side: push either the bow thruster lever or the stern thruster lever to the desired side.
- Disengage both thrusters: Move either the bow thruster lever or the stern thruster lever to the opposite side.
- Increase the power of a thruster: push the lever of the thruster whose power you want to increase; each push on the lever will increase power by 2%.

The initial activation power value for each thruster is the one set in the "Hold Thrust" parameters menu (See sections 4.3.2.3 and 4.3.2.4).



*Using the Hold mode with on/off type thrusters that can only be activated at 100% power may be inappropriate. In this case it is recommended that you try PPC. If the result is still inappropriate or uncomfortable, we recommend that you do not use the Hold function.*

*The HOLD function has a timeout of 600 seconds. A warning will be displayed on the screen after 550 seconds.*

### 3.4 DPS mode

Shipcontroller DPS (Dynamic Positioning System) is an automatic control system that allows the ship's position and heading to be maintained stable, within estimated error margins.

Shipcontroller DPS includes the following elements:

- An NRU (Navigation Reference Unit). Essentially, it consists of a GNSS receiver with a heading sensor and attitude sensors. The DPS system uses the NRU to gather the position, orientation, and attitude of the ship.
- A DPS processor unit, which compares the ship's position and heading with the reference position and heading. This processor calculates the necessary maneuvers to be carried out with the ship's thrusters and engines in order to correct the ship's position and try to keep it in the set position.
- The Shipcontroller control system, which allows you to interact with the ship's propulsion systems.

*For safety reasons, and to achieve proper performance of the DPS system, it is essential that you carefully read, note, and accept the following warnings or recommendations, in addition to the warnings and recommendations in the DPS module user manual:*



***Once turned on, the Shipcontroller's DPS system may activate the thrusters or engines at any time. Keep a constant eye on the boat's position and heading, and make sure there are no people or things near the boat, and especially near the propellers or thrusters.***

***The ability of the DPS system to maintain position and heading accurately is limited, primarily, by the power that the engines and thrusters are able to deliver to the DPS system, and by the precision and accuracy of the NRU reference system.***

There are circumstances that will prevent the DPS system from working properly:

- Strong winds, waves and/or currents that cause a drift that cannot be corrected with the power available to the DPS control system.
- Inability of the thrusters or engines to function continuously, in case of high demand by the DPS system. (For example, electric thrusters with limited battery capacity that cannot run for more than a few minutes continuously.)
- Failure of the GNSS satellite system, poor coverage of the GNSS signal, or loss of data quality (high PDOP, HDOP values).

The DPS system cannot be started until the NRU unit delivers a stable position and heading signal with the quality level established by default.

The DPS system will signal alarm situations by means of an audible signal from the DPS module, and also by means of an indication on the remote. Normally the DPS system will deactivate when an alarm occurs. The alarm will be activated in the following cases:

- If the NRU system signal is lost, or the quality of position and heading data are degraded.
- If the DPS system fails to keep the ship within a predetermined radius.
- If engine control is lost.

### 3.4.1 DPS activation

If a Shipcontroller DPS module is installed, the DPS option will be available on the operating mode selection screen.

1. Press the (\*) button to activate the mode selection screen, and choose and activate the DPS mode. If the DPS system is ready to be activated, the display will change to the DPS Information screen. (See 3.4.2).
2. If the DPS system is not ready the display will show an information message. You can wait until the DP system is operational, or press ">" and "Esc" to return to Docking mode.

Activating the DPS system will set the current position and heading as the reference position and heading. From this moment the DPS system will control the engines and thrusters to try to keep the boat in the chosen position and heading.

### 3.4.2 DP Information screen

This screen will display the following information:

- Position and heading of the ship relative to the set position.
- Distance from the boat to the chosen reference position. (D, meter).
- Bearing angle from the boat to the set position. (B, degrees).
- NRU status: The icon is a satellite that will indicate by blinking that we are receiving data from the NRU sensor.
- GNSS data quality indicator: A bar graph indicating the relative level of quality of the GNSS signal.
- Thrust Status Indicator: Shows the activation status of the engines and thrusters using triangles that turn black when the corresponding thruster or engine is activated.
- An arrow indicating the direction of the drift. (Only shown if the radius is > 75cm).

- Press the (SC) button briefly to return to the DPS activation screen.

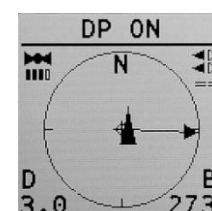
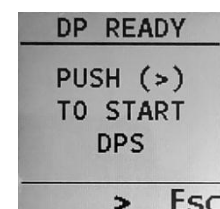
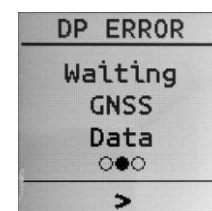

### 3.4.3 Reactivation and deactivation of the DPS system

When the DPS system is activated, a short press of the (SC) button will toggle between the DPS Info and DPS Activation screens. Also, if you use the Joystick while the DP is on, the DP will be temporarily disabled and the setpoint will reset when you leave the Joystick idle.

If the DPS is activated, the DPS Activation screen will show “DPS ON” as its title. Then this screen will allow you to take the following actions:

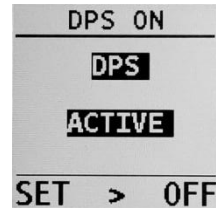

- SET: pressing this button will reactivate the DPS, taking the current position and heading as reference.
- (>): Return to DP Info screen.
- OFF: The DPS will be deactivated. The screen will change to “DPS Ready”.

### 3.4.4 Exiting DPS mode

DPS can be disabled in one of the following ways:

- Selecting a different operating mode (pressing the mode select button [\*] to change the mode, and confirming the selection).
- By pressing the [SC] key while in the DPS Info screen, and then pressing OFF.
- Turning off the remote.

### 3.4.5 DPS operation notes and tips

If the DPS is activated, the following cases will cause the DPS to be deactivated and an audible alarm to be triggered in the DPS module:

- The remote turns off or loses radio coverage
- Engines control is lost.
- The satellite signal from the NRU sensor loses quality, or is simply not available.
- The distance from the ship to the reference position exceeds a preset limit.
- The DPS module detects a fatal error condition.

When the DPS module is disabled, thrusters and engines will immediately go to neutral.

## 3.5 Autopilot control mode

If your Shipcontroller system includes an autopilot control module, the AP option will appear as available on the operating mode selection screen, and you will therefore be able to activate this mode.



When you activate the AP mode, the AUTOPILOT screen will be displayed.

This screen will display information according to the current status of the AP (Auto/Standby).

#### Autopilot (AP) in STANDBY mode:

The screen will show the following AP parameters:

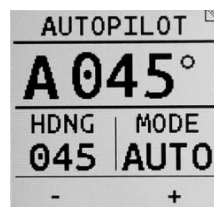

- Autopilot course (degrees).
- AP heading (degrees).
- AP mode: STBY.

- Press the (SC) button to access the AP MENU screen.

### Autopilot in AUTO mode:

The screen will show the following AP parameters:

- Autopilot course (degrees).
  - AP Heading (degrees).
  - AP Mode: AUTO.
- Press the (SC) button to access the AP MENU screen
  - Press the (+) button briefly to increase the AP course by 1 degree.
  - Press and hold the (+) button to increase the AP course in steps of 10 degrees.
  - Press the (-) button briefly to decrease the AP course by 1 degree.
  - Press and hold the (-) button to decrease the AP course in steps of 10 degrees.

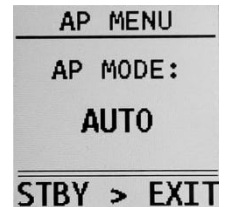

### 3.5.1 AUTOPILOT MODE screen

This screen allows you to change the autopilot status (Auto/Standby), or exit the AP mode:

- Press the (SC) button briefly to return to the AUTOPILOT screen.
- Press the AUTO or STBY button to change the autopilot status.
- Press the (EXIT) button to exit AP mode and return to DOCKING mode.



## 3.6 RC (Remote control) mode

The RC (Remote Control) mode will be enabled on the operation mode selection screen if a suitable expansion module is connected to the Shipcontroller system.

Two modules are currently available:

- Engine start/stop module. It allows remote start and stop of up to two engines with non-electronic ignition system.
- Relay output expansion module. It allows remote control of up to 8 relay outputs, which can be configured as temporary or toggle.

Please read the manual of the expansion module for details on the way of operation.

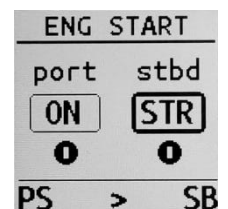
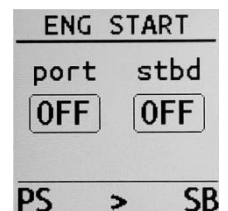



## 3.7 Using the Joystick to control engines and thrusters

### a) Default configuration mode (SCR756JY-SW)

The joystick of the 756JY remote allows movements along the X, Y, Z axes. The Z axis (joystick rotation) controls the rotation of the ship. The rotation mode can be set to use the engines, thrusters, both at once, or neither (Z axis overridden). See section 4.3.2.5 for more information about the rotation settings.

The X Axis controls both thrusters at the same time, to move the boat laterally. If proportional control or PPC control of the thrusters is available, you can even adjust different levels of thrust to get the boat moving truly sideways.

The engines are controlled by the combination of the X and Y axes. Forward and reverse maneuvers are possible with both engines, or with just one. The diagram below shows a summary of the maneuvering alternatives using the X and Y axes:

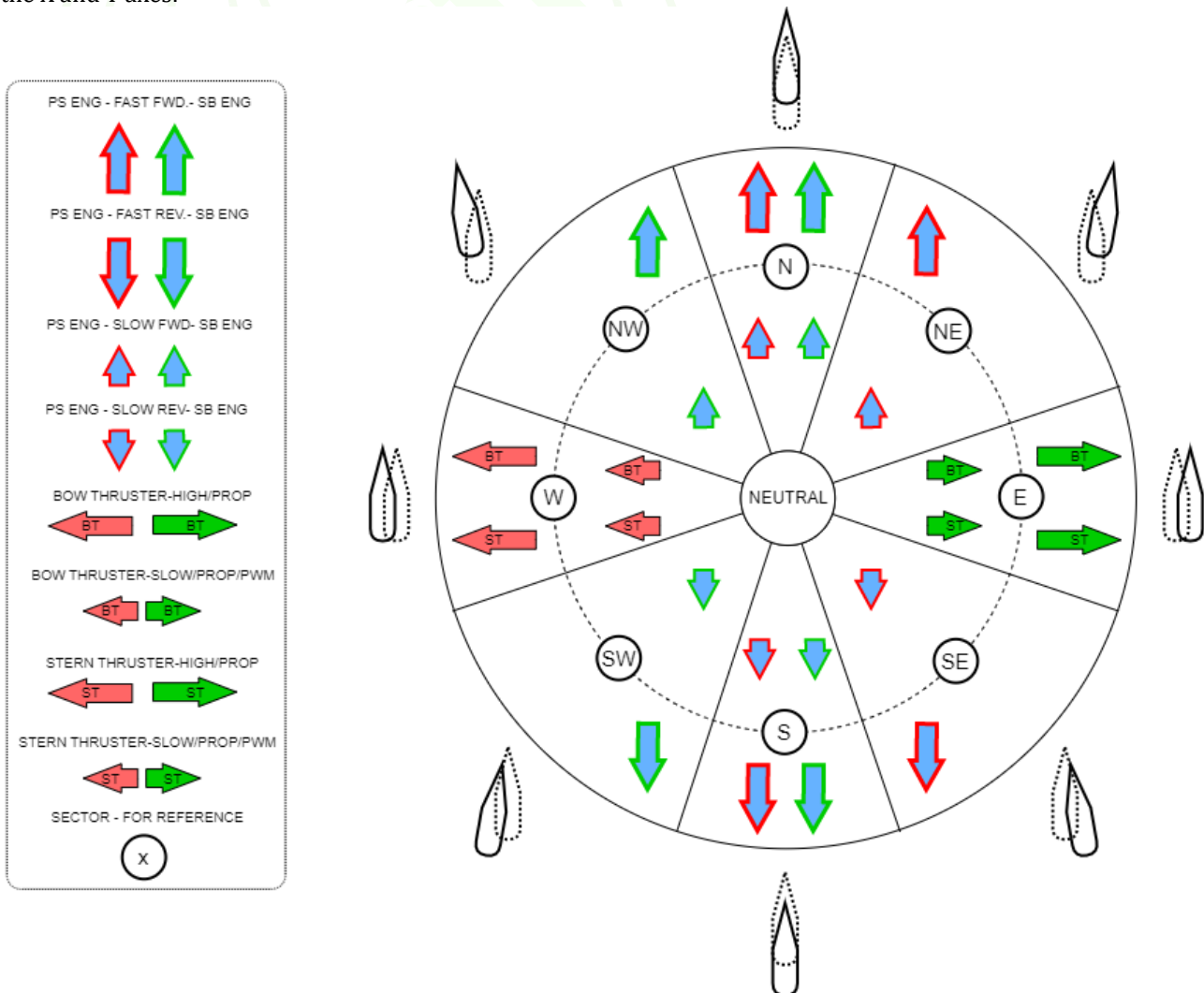

### b) IPS configuration mode (SCR756JY-IPS)

In IPS mode, the joystick in the remote unit will behave similarly to the boat's IPS Joystick. Simply push the joystick in the direction you want the boat to move and the IPS system will take care of executing the appropriate maneuver.

## 4 Remote unit settings

The settings of this unit are organized in three blocks:

- User Settings:
  - They include the settings that the user may need to access frequently, such as the depth alarm, the speed lock, and other non-critical settings.
- System settings:
  - This block includes the propulsion control adjustment and other essential system settings.
  - Usually, this block of settings is accessed only during the installation of the Shipcontroller system, in order to configure it and adapt it to the characteristics of the ship.
  - Access to these settings must be made only by trained technical personnel.
- System information:
  - To check usage information, radio coverage, etc.

### Settings persistence:

Any changes to the settings will automatically be written into the internal permanent memory.

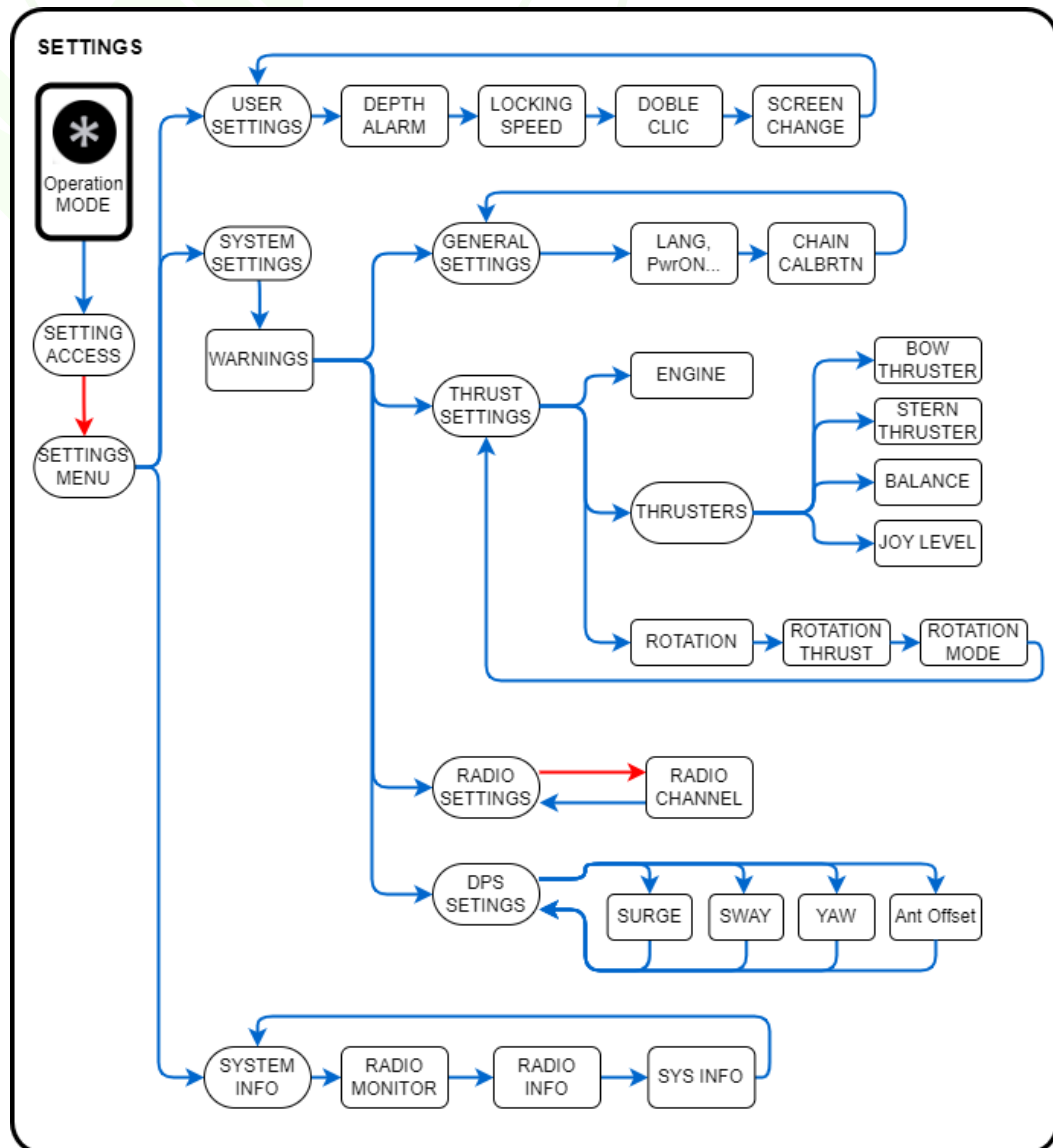

## 4.1 Entering settings

1. Press the operation mode selection button (\*) to activate the operation mode menu on the screen.
2. Press the same button briefly several times to select the SETTINGS mode.
3. Keep the (\*) button pressed to bring up the screen that gives access to the settings system.
4. Press and hold the (SC) button until the main settings menu appears.

Alternatively, you can use the SEL (-) and (SC) buttons to choose a mode and activate it.

Once you have accessed the main settings menu, use the menu buttons to select an option, activate it, or exit to the previous menu:

- The SEL (-) button allows you to select an option.
- The > (SC) button activates the chosen option.
- The Esc (+) button leads you to the previous menu. (Or to exit settings if you are in the main menu).

## 4.2 User settings

### 4.2.1 Depth alarm

Through this screen you can adjust the triggering depth value of the depth alarm.

- Press the (+) or (-) buttons to increase or decrease the alarm depth value.
- Press the (>) button to access the next user settings screen.
- To disable the depth alarm, set the alarm level to 0.

### 4.2.2 Thruster and windlass locking speed

Through this screen you can adjust the speed of the boat from which the use of the thrusters and windlasses will be blocked.

- Press the (+) or (-) buttons to change the locking speed.
- Press the (>) button to access the next user settings screen.
- To disable this feature, set the speed to 0.

### 4.2.3 Doble Clic sensitivity

This setting is reserved for future use.

- Press the (>) button to access the next user settings screen.

### 4.2.4 Auto screen change

This setting allows you to enable or disable the automatic screen switching feature:

- Press the (DIS) button to disable this feature (when enabled).
- Press the (ENA) button to enable this feature (when disabled).
- Press the (>) button to return to the main settings menu.

The automatic screen switching function works when the DOCKING mode is activated. If automatic screen change is enabled:

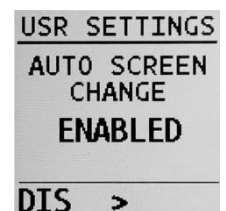
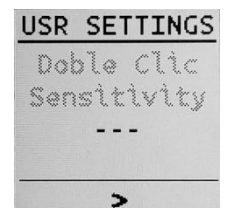
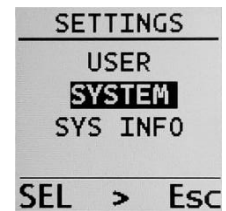
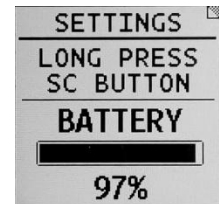
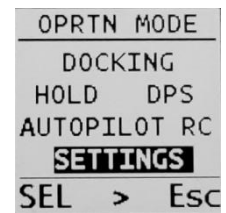

- When you activate an engine or thruster control (lever or button), the MANEUVER screen will automatically activate, so you can see how the maneuver is being executed. If the controls become inactive, it will automatically return to the previous screen.
- When you operate a windlass control button, the screen will automatically change to the CHAIN COUNTER mode. If the windlass controls become inactive, it will automatically return to the previous screen.

## 4.3 System Settings



*Changes in SYSTEM settings must only be made by properly trained and qualified technical personnel. Mistakes or improper settings can result in inappropriate behavior of the ship's propulsion or maneuvering systems.*

*Always check the operation of all systems managed by Shipcontroller after making changes to system settings. Please carefully read the instructions and safety warnings in this manual and the warnings on the SCR756 unit when accessing system settings.*

### Warning messages:

When you enter the system settings for the first time after turning on the unit, warning messages will be displayed. Acknowledge the messages by pressing the (>) button until you enter the main system settings menu.

### System Settings menu:

- Press the (SEL) button to select a menu option.
- Press the (>) button to activate the selected option.
- Press the (Esc) button to return to the previous menu.

### 4.3.1 General settings

#### 4.3.1.1 Language, Power On Mode, Units, Windlass Memory

- Press the (SEL) button to select a menu option.
- Press the (SET) to change the selected option value.
- Press the (>) button to go to the next settings screen.

### Options:

- Language: select ESP (Spanish) or ENG (English).
- PWR ON: select the remote starting mode:
  - Norm: Normal. The remote starts after briefly pressing the power button.
  - Safe: two-phase start. After pushing the power button, the user must push the (SC) button.
- UNITS: select Ft (feet) or Meter.
- MEM WL: memorize the selected windlass. The remote will save the latest used windlass so that when you turn on the remote again the same windlass is selected.

#### 4.3.1.2 Chain calibration

This setting allows you to set the chain length, in mm, to which each chain counter sensor pulse is equivalent.

You should set this value to the middle circumference of the anchor windlass capstan. It is common to have to do some testing and readjustment to improve the accuracy of the chain counter.

- Press the (-) or (+) buttons to change the mm/pulse value.
- Press the (>) button to go to the next settings screen or return to the previous menu.

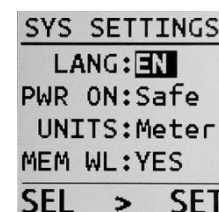
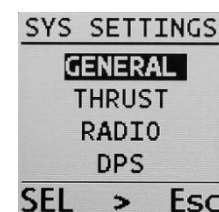
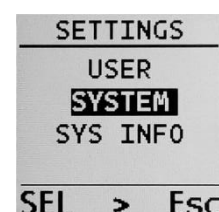

## 4.3.2 Thrust settings

This screen allows you to access the thrust settings for the engines and thrusters. The options displayed on the screen depend on the configuration of the remote:

### a) Default configuration mode (SCR756JY-SW)

The screen will show the following options: ENGINE, BOW TH, STERN TH and ROTATION.

- Press the (SEL) button to select a menu option.
- Press the (>) button to enter the selected option.
- Press the (Esc) button to return to the previous menu.

### b) IPS configuration mode (SCR756JY-IPS)

The screen will show the following options: ROTATION, BOW TH and STERN TH.

- Press the (SEL) button to select a menu option.
- Press the (>) button to enter the selected option.
- Press the (Esc) button to return to the previous menu.

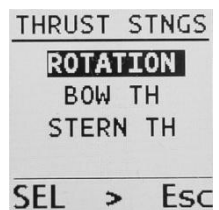
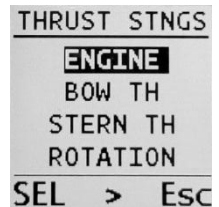

### 4.3.2.1 Precise Pulse Control (PPC)

PPC stands for *Precise Pulse Control*. It is an exclusive Shipcontroller technique which allows engines or thrusters to be activated and deactivated periodically, under very precise timing, in order to reduce their average thrust. This is very useful when, for example, the engines provide too much thrust at idle.

When the PPC control mode is activated, we must set two parameters:

- Cycle: Repeat period (seconds).
- Ton: Activation time (seconds).

For example, if we set Cycle = 3sec, and Ton = 1sec, the engine will engage for 1 second out of every 3 seconds when we use the "slow" speed for engine control on the remote. That is, the average thrust obtained will be 33% of the idle thrust.

The PPC feature can also be used to obtain engine thrust impulses of a precise duration.

### 4.3.2.2 Engine thrust settings (Only for the default configuration mode SCR756JY-SW)

Through this screen we can set the engine control mode, the engine thrust adjustments and the PPC control mode. It is an essential adjustment.

*The SCR756 remote has engine control levers and buttons that allow us to carry out two engine control actions: Slow and Fast.*



#### Engine control modes:

There are three basic types of engine control modes, depending on the type of Shipcontroller engine interface installed in the boat. The engine control mode must be set according to the type of engine interface used:

#### 1) Proportional engine control interface:

- It is capable of accepting continuous thrust values within a given value range; for example: from -25% to +25%.



- It permits us to adjust the thrust values corresponding to the Slow and Fast remote commands sent to the engines.
- Example: if we set the "Low" thrust to 5% and the "High" thrust to 20%, a thrust value of 5% will be sent to the engine when we push the Slow engine lever on the remote. When we use the Fast button or the "Doble Clic" functions of the Slow lever, a 20% thrust command will be sent to the engine.
- The PPC feature can be used with this type of interface. If we use the PPC feature:
  - The Slow speed will be that of the idle-gearred engines applying PPC.
  - The Fast speed will correspond to the one set for "High".

### 2) Dual speed engine control interface:

- This interface supports two levels of thrust, which are set at the time of installation. Usually the Slow speed corresponds to that of the engines at idle, and the High speed is set to increase the engine rpm a bit.
- These two thrust levels correspond to the Slow and Fast engine control commands on the remote.
- The PPC feature can be used with this type of interface. If we use the PPC feature:
  - The Slow remote engine commands will activate the "Low" speed in the adapter applying PPC.
  - The Fast remote commands will activate the "High" speed in the engine interface adapter.

### 3) Single speed engine control interface:

- This interface only supports gearing the engines at idle.
- The PPC feature can be used with this type of interface. If we use the PPC feature:
  - The Slow engine commands will activate the engines engaged in idle applying PPC
  - The Fast command will engage the corresponding engine at idle.

ENGINE STNGS	ENGINE STNGS	ENGINE STNGS	ENGINE STNGS	ENGINE STNGS	ENGINE STNGS
<b>MODE: PROP</b> Low: 1% High: 25%	<b>MODE: PR+PPC</b> Cycle: 2.0s Ton: 1.0s High: 25%	<b>MODE: DS</b> Low: CAL L High: CAL H	<b>MODE: SS</b> Low: ENGAGE High: ENGAGE	<b>MODE: DS+PPC</b> Cycle: 2.0s Ton: 1.0s High: 25%	<b>MODE: SS+PPC</b> Cycle: 2.0s Ton: 1.0s High: ENGAGE
- > +	- > +	SEL > Esc	SEL > Esc	- > +	- > +

To set the various parameters relating to the engine control modes, do the following:

1) Select the parameter you want to change, and enter the edit mode:

- Press the (SEL) button to select a menu option.
- Press the (>) button to enter the parameter edition mode.
- Press the (Esc) button to return to the previous menu.

2) In parameter edition mode, modify the parameter value:

- Press the (+) or (-) buttons to change the selected parameter value.
- Press the (>) button to exit the parameter edition mode.

The following table summarizes the engine control modes and the different parameters associated with each mode:

Engine interface type	Engine control mode	Parameters	"Slow" engine command	"Fast" engine command
Proportional	PROP	Low thrust High thrust	Low thrust	High thrust
	PR+PPC	PPC Cycle time PPC T <sub>on</sub> time High Thrust	Engaged at idle+PPC	High thrust
Dual speed	DS		Engine interface adjusted thrust for "low" speed	Engine interface adjusted thrust for "high" speed
	DS+PPC	PPC Cycle time PPC T <sub>on</sub> time	Engaged at idle+PPC	Engine interface adjusted thrust for "high" speed
Single Speed	SS		Engaged idle	Idle engaged
	SS+PPC	PPC Cycle time PPC T <sub>on</sub> time	Engaged at idle+PPC	Engaged idle

#### 4.3.2.3 Thrusters settings

Thanks to the Doble Clic technology, we have two levels of thrust on the remote when we use the levers or control buttons of the thrusters. We will refer to these two thrust levels for the thrusters as "Low" and "High".



In addition, the "Hold" mode for the thrusters will allow us to adjust the thrust levels incrementally, according to our needs.

In the table below we refer to the "thruster commands". These commands are as follows:

- Normal operation mode: this command activates the *Slow thrust* mode.
- *Doble Clic* operation mode: this command activates the *Fast thrust* mode.
- "Hold" operation mode: this command activates the *Hold thrust* mode.

#### Thruster types:

We will distinguish two basic types of thrusters depending on the characteristics of the thruster itself and the control capabilities of the Shipcontroller thruster interface:

1. Proportional control thruster:
  - The thruster accepts variable speed thrust commands, typically between 0% and 100% thrust.
  - A suitable proportional Shipcontroller control interface must be fitted.
  - The remote will be able to send proportional thrust commands to the thruster.
2. On/off thrusters or on/off controlled proportional thrusters:
  - This type of thruster only accepts on/off commands.
  - The remote will be able to send On/Off command to the thruster. The PPC control mode will be available.

The following table summarizes the thruster control modes and the different parameters associated with each mode:

Thruster type	Thruster control mode	Parameters	“Low” thruster command	“High” thruster command	Hold thruster command
(No Thruster)	(None)	(None)			
Proportional	PROP	Low thrust High thrust Hold thrust	Low thrust	High thrust	Hold thrust
On/Off	On/Off	(None)	Thruster ON	Thruster ON	
	PPC	PPC Cycle time PPC T <sub>on</sub> time PPC T <sub>hold</sub> time	PPC	Thruster ON	PPC Hold

```

BOW THRSTR
MODE: n/a
NOT
AVAILABLE
- > +

```

```

BOW THRSTR
MODE: PROP
Low: 50%
High: 80%
Hold: 5%
- > +

```

```

BOW THRSTR
MODE: PPC
Cycle: 2.0
Ton: 1.0
HIGH: 100%
- > +

```

```

BOW THRSTR
MODE: OnOff
Low: 100%
High: 100%
Hold: n/a
- > +

```

To set the various parameters relating to the thruster control modes, do the following:

1) Select the parameter you want to change, and enter edit mode:

- Press the (SEL) button to select a menu option or a parameter.
- Press the (>) button to enter the parameter edition mode.
- Press the (Esc) button to return to the previous menu.

```

THRUSTERS
BOW TH
STERN TH
BALANCE
JOY.LEVEL
SEL > Esc

```

2) In parameter edition mode, modify the parameter value:

- Press the (+) or (-) buttons to change the selected parameter value.
- Press the (>) button to exit the parameter edition mode.

**Bow/Stern thruster settings:**

To set the various parameters relating to the bow thruster, do the following:

- 1) Navigate to Settings -> System -> Thrust -> Thrusters Menu.
- 2) The BOW TH option is selected by default. Otherwise, use (SEL) to select BOW TH or STERN TH.
- 3) Press the (>) button to enter the bow thruster parameters screen.
- 4) The MODE parameter is selected by default. Otherwise, use (SEL) to select MODE.
- 5) Press (>) to enter MODE edition. Press the (+) or (-) buttons to change the thruster MODE. When changing modes the parameters under MODE may change.
- 6) Press (>) to exit MODE edition.
- 7) If the chosen mode includes any configurable parameters:
  - a. Press the (SEL) button to select the parameter.
  - b. Press the (>) button to enter the parameter edition mode.
  - c. Press the (+) or (-) buttons to change the parameter value.
  - d. Press the (>) button to exit the parameter edition mode.
- 8) Repeat 7) until you have adjusted all the parameter values; then press (Esc) to return to the previous screen.

**Thrusters balance:**

Thruster balance is only applicable in normal mode (not IPS mode), and only if you have proportional bow and stern thrusters.

The balance setting allows the thrust of the thrusters to be distributed to compensate for the different thrust of the bow/stern thrusters, so that the boat moves almost parallel when we move the joystick in the X axis.

To set the thrusters balance, do the following:

1. Navigate to Settings -> Thrust -> Thrusters -> Balance screen.
2. Press the corresponding (+) buttons to change the bow/stern balance.
3. When you're done, press (>) to return to the previous screen.

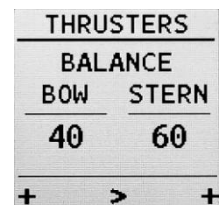

Notes:

- The maximum values of the balance parameter are 30/70 and 70/30
- You can hold the (+) buttons for faster adjustment.

**Joystick X-axis start thrusters thrust**

Joystick X-axis thrusters thrust is only applicable in normal mode (not IPS mode), and only if you have proportional bow **or** stern thrusters.

This setting allows you to set the minimum thrust for the thrusters when moving the joystick in the X axis.

1. Navigate to Settings -> Thrust -> Thrusters -> JOY.LEVEL.
2. Press the (+) or (-) buttons to change the X-axis starting thrust.
3. When you're done, press (>) to return to the previous screen.

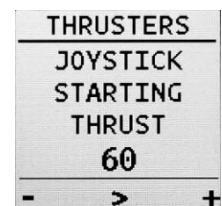

Notes:

- The minimum value for this parameter is 20. The maximum value is 80.
- You can hold the (+) buttons for faster adjustment.

#### 4.3.2.4 Rotation settings

These settings allow us to set the way the ship's rotation is executed when we rotate using the joystick.

##### 4.3.2.5.1 Default configuration mode (SCR756JY-SW)

###### Rotation Thrust:

The rotation thrust adjustment allows us to set the power that will be applied to the thrusters when we rotate the Z axis of the Joystick.

This adjustment is only possible when the bow and stern thrusters have proportional control. Otherwise, the display will show the message "Only for proportional thrusters".

- Press (+) to increase thrust.
- Press (-) to decrease thrust.
- Press (SC) to advance to the next screen of rotation settings.

###### Notes:

- The minimum value for this parameter is 40. The maximum value is 100.
- You can hold the (+) buttons for faster adjustment.

###### Rotation Mode:

This setting refers to the way the boat rotation maneuver is executed when we turn the joystick. Four modes are possible:

- Z axis disabled: When we rotate the joystick, no maneuver will be executed. That is, the Z axis of the joystick will be disabled.
  - Engines Only: when we turn the joystick, one engine will be activated forward and the other backward, causing the boat to rotate.
  - Thrusters only: when we turn the joystick, the bow thruster will be activated to one side, and the stern thruster to the opposite side.
  - Engines and Thrusters: when we turn the joystick the engines and thrusters will be activated to rotate the boat.
- Press (+) to select the next rotation mode.
  - Press (-) to select the previous rotation mode.
  - Press (SC) to return to the thrust menu.

##### 4.3.2.5.2 IPS configuration mode (SCR756JY-IPS)

In case of IPS configuration mode, only the rotation thrust setting is available.

The rotation will be carried out by the IPS system using the configured thrust value. That is, it is not possible to select a rotation mode for the thrusters.

However, since the 756JY remote has, in addition to the joystick, independent push buttons to control the thrusters, the user can achieve the rotation of the boat by activating the bow and stern thrusters in opposite directions.

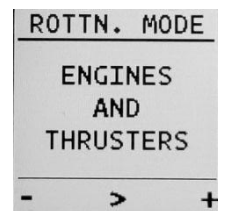
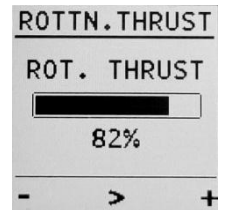



### 4.3.3 Radio settings

Through this settings screen you can change the main radio channel used by the Shipcontroller system. This is useful when there is a strong interfering radio signal in the 2.4GHz band. It is very rare for this to happen. If necessary, we recommend that you contact the technical support of your Shipcontroller distributor to help analyze the problem and choose the appropriate channel.

#### Radio channel change procedure:

- 1) The procedure must be carried out with the remote close to the base transponder. (Within 5m).
- 2) Navigate to the channel change screen.
- 3) Use the (+) or (-) buttons to select the new channel. By changing the channel, the remote will lose connection with the base. (The red led on the remote will indicate that there is no connection).
- 4) Press and hold the (SC) button to start the channel change procedure.
- 5) Wait for the channel change procedure to finish.
- 6) Exit the channel change screen by briefly pressing the (SC) button.



*A failure in the channel change procedure can cause the remote to fail to connect to the base. If this occurs, simply repeat the channel change procedure.*

```
SYS SETTINGS
GENERAL
THRUST
RADIO
SEL > Esc
```

```
RADIO CH
Channel: 26
#: 21 22 23 24
B: 75 ^ ^ ^
R: 73 ^ ^ ^
- > +
```

```
<CH SYNC>
CH: 15
<<SCANNING>>
DO NOT
SWITCH OFF
```

### 4.3.4 DPS Settings

If your Shipcontroller system includes a DPS module, and it is active, the system settings menu will include a "DPS" option. If there is no DPS system or it is powered off, the DPS settings will not be available.

Shipcontroller's DPS system is delivered factory calibrated, which makes installation and commissioning quick and easy. However, Due to the different characteristics of the hull and the propulsion elements of each boat, it is necessary to carry out a personalized adjustment of the DPS system.



The smart antenna is an essential part of the DPS system which provides highly accurate position and heading data.

Remember that, most likely, the ship's position and course receivers will have worse accuracy than the Shipcontroller's DPS system smart antenna, so they will not be a good reference to know if the ship is holding position.

This antenna must be placed in the central bow/stern axis, and as close as possible to the center of rotation of the boat. In some cases it is not possible to achieve the ideal location, so adjustments have been included to correct the deviation of the antenna position from the ideal position.



***The DPS adjustments must be made by trained and authorized personnel. Incorrect settings can cause inappropriate behavior of the DPS system.***

Please keep these tips on DPS Shipcontroller system settings in mind:

- The Shipcontroller system (excluding the DPS) must have been fully tested and adjusted before adjusting the DPS system.
- DPS adjustments should be made in clear water, always keeping a good lookout, and with weak winds and currents. It is better to stand near a buoy or a mark, and look at it as a reference.
- The ship's compass can be an acceptable reference for the ship's heading, but the ship's GNSS surely has a significant error compared to the DPS system's smart antenna. It is better to look at the Shipcontroller remote screen to see the position deviation.
- Remember that when even if DPS is activated, you still have direct control of the ship by using the remote controls (thrusters, engines). The DPS will deactivate and reactivate when you release the remote controls.
- Please note that for the purposes of the DPS system,
  - The engines are responsible for maintaining the position in the longitudinal direction (Y axis, surge). Remember to make sure the rudder is centered when using the DPS!
  - The thrusters are responsible for moving the boat laterally (X axis, Sway), and also for maintaining the boat's heading (Z axis, Yaw).
- During the DPS adjustments, try to mentally separate the movements in each of the axes, treating them separately.
- Please remember that the available power from the thrusters and motors is limited, and that there might be circumstances in which the DPS system will not be able to hold position. As a general rule, if you can't manually hold the ship in position using the thrusters and motors (only with the same power available to the Shipcontroller), then the DPS system won't be able to either.

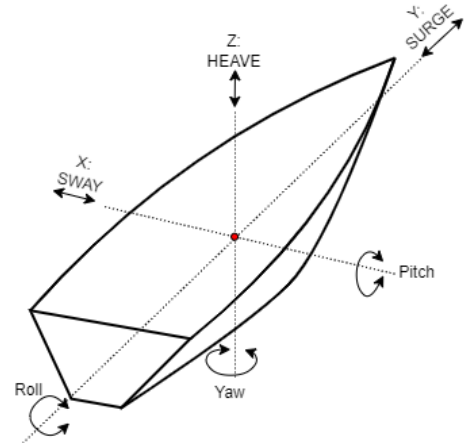

SYS SETTINGS	
GENERAL	
THRUST	
RADIO	
DPS	
SEL	> Esc

DPS SETTINGS	
Surge (Y)	
Sway (X)	
Yaw (Z)	
Ant Offset	
SEL	> Esc

#### 4.3.4.1 Gain and damp settings

Shipcontroller's DPS system constantly calculates and monitors deviations from the selected reference position on three axes:

- Surge (Y axis, fore-aft axis).
- Sway (X axis, lateral axis).
- Yaw (Z axis, ship rotation).

There are two possible settings for each of the three axes:

- Gain. This parameter sets the amount of thrust that will be applied to the corresponding axis.
  - Maximum value: 100. Minimum value: 1. Step: 1.
- Damp. This parameter helps to correct possible oscillations around the reference position.
  - Maximum value: 250. Minimum value: 1. Step: 1.

To set the DPS axis settings, do the following:

1. Navigate to Settings -> System -> DPS settings menu.
2. Press the (SEL) button to select Surge/Sway/Yaw axis.
3. Press the (>) button to enter the corresponding settings screen.
4. You will see two options appear on the screen: GAIN and DAMP. Select the one you want to change by pressing the (SEL) button, and then press the (>) button to enter the parameter editing mode.
5. In edit mode the lower menu will have changed, and will now show the (-) and (+) buttons. Use those buttons to change the value of the parameter.
6. Push the (>) button to save the parameter and exit the parameter edition mode.
7. When you have finished the adjustments of this axis, press the (Esc) button to return to the previous menu.
8. Repeat the steps from point 2) until completing all axis adjustments.

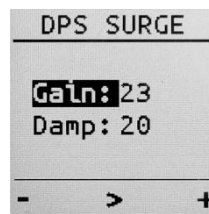
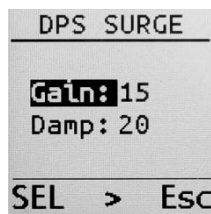
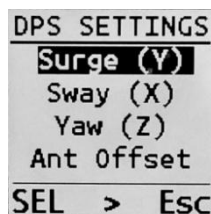

#### 4.3.4.2 Antenna offset settings

For best results, the Shipcontroller smart antenna should be located as close to the pivot point as possible. We refer to the pivot point, or center of rotation when we perform boat rotation maneuvers using the thrusters.

The position of the pivot point for the thrusters can be established experimentally, in an approximate way, applying the bow thruster 100% to starboard, and the stern thruster 100% to port, trying to estimate which point on the axis of the ship does not move laterally, or does it to a lesser extent.

The unit of the antenna offset adjustments is the centimeter. If the antenna is forward of the PP (Pivot Point), the X offset will be considered positive, and also if the antenna is to starboard of the center line. If the antenna is aft or port, the corresponding offsets for the Y and X axes will be negative.

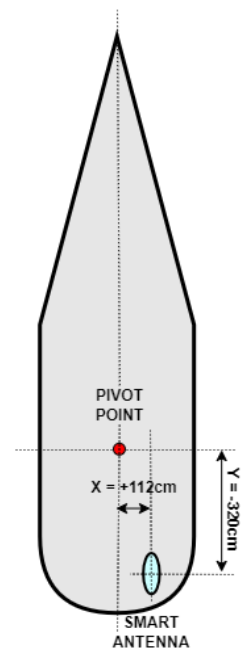

To set the antenna offsets:

1. Navigate to Settings -> System -> DPS settings menu.
2. Press the (SEL) button to select Ant. Offset option. Press the (>) button to enter the antenna offset settings screen.
3. You will see two options appear on the screen: X (cm) and Y (cm). Select the one you want to change by pressing the (SEL) button, and then press the (>) button to enter the parameter editing mode.
4. In edit mode the lower menu will have changed, and will now show the (-) and (+) buttons. Use those buttons to change the value of the parameter.
5. Push the (>) button to save the parameter and exit the parameter edition mode.
6. When you have finished the adjustments press the (Esc) button to return to the previous menu.

```
DPS SETTINGS
Surge (Y)
Sway (X)
Yaw (Z)
Ant Offset
SEL > Esc
```

```
DPS SETTINGS
Surge
Sway
Yaw
Ant Offset
SEL > Esc
```

```
Ant Offset
+ Bow/SB
- Stern/PS
X(cm): 0
Y(cm): 500
SEL > Esc
```

#### 4.3.4.3 DPS adjustment procedure

The adjustment procedure, for each axis, is based on these rules or tips:

- First adjust the antenna position offsets. For the axis damping and gain settings, we recommend starting with the default DPS system settings. With these settings the ship should maintain position with a low position error.
- It is better to make the first settings in good weather (light currents and winds).
- As a general rule of thumb:
  - If you want to reduce the position error for a given axis, or you find that the thrust for that axis kicks in when the position error (on that axis) is too high, increase the gain on that axis.
  - If you set the gain too high, the drive for that axis will be constantly switching on and off, and will likely oscillate around the reference position (0 for that axis).
  - If the thrust of an axis is activated with the desired position error, but when moving the ship passes the reference position in the opposite direction, you can try increasing the damping.
  - Increasing the damping will help reduce oscillations. But too high damping can cause unstable behavior, or make the response of the DPS system too slow.
  - Decreasing the damping may cause the boat to return to the set position more quickly. But if you reduce it too much, you may see oscillations around the set point.

## 4.4 System Information

This section includes 3 informative screens, which are described below.

### 4.4.1 Radio Monitor

This screen displays real-time information on the status and quality of the radio link between the remote unit and the base unit. This screen contains the following information, organized in columns:

- #: Base transceiver number. Small and medium boats will have only one transceiver, numbered 21. Large Shipcontroller deployments (NET version) may have up to eight base transceivers, sequentially numbered.
  - Data reception indicator. The small bar next to the base transceiver number will move up and down while the base is receiving information from the Shipcontroller CANbus.
  - ER: Error count. This counter resets itself when it reaches 99. A quick increasing value indicates no radio coverage, or a base transceiver fault.
  - R>B: relative power level (0 to 99) of the radio signal transmitted from the remote to the base transceiver.
  - B>R: relative power level (0 to 99) of the radio signal transmitted from the base transceiver to the remote unit.
- Press the [SC] button briefly to go to the next screen.

RF	MNTR	R:1
#	ER	R>B B>R
21	1	█ █
22	3	█ █
23	2	█ █
24		

RF	MNTR	R:1
#	ER	R>B B>R
21	0	█ █
22		
23		
24		

### 4.4.2 Radio Information

- ID: System identification. Together with other parameters it identifies the radio system.
- SL: Radio serial number. This number is part of your system's unique identifier.
- MY: Remote number. In systems with several remotes, this number allows them to be differentiated, so that two remotes cannot take control at the same time.
- PL: Radio power level indicator. In the standard configurations this value must be = 4.
- CH: Operational radio channel. (Hex value).

➤ Press the [SC] button briefly to go to the next screen.

<RADIO INFO>
ID: 0001
SL: 41FB 4290
MY: 01
PL: 04 CH: 1A
> Esc

### 4.4.3 System information

This screen displays the following information:

- Remote serial number.
- Remote model.
- Number of times the remote has been turned on.
- Time the remote has been on.

➤ Press the [SC] button briefly to go to the next screen.

SYS INFO
0000x0001
756TGv10
#On: 1
0000:18:57.0
> Esc



## 4.5 Battery charging

The remote control unit includes an internal rechargeable battery and circuitry for contactless, wireless charging. The Qi standard is widely used in mobile phones.

In order to charge the internal battery:

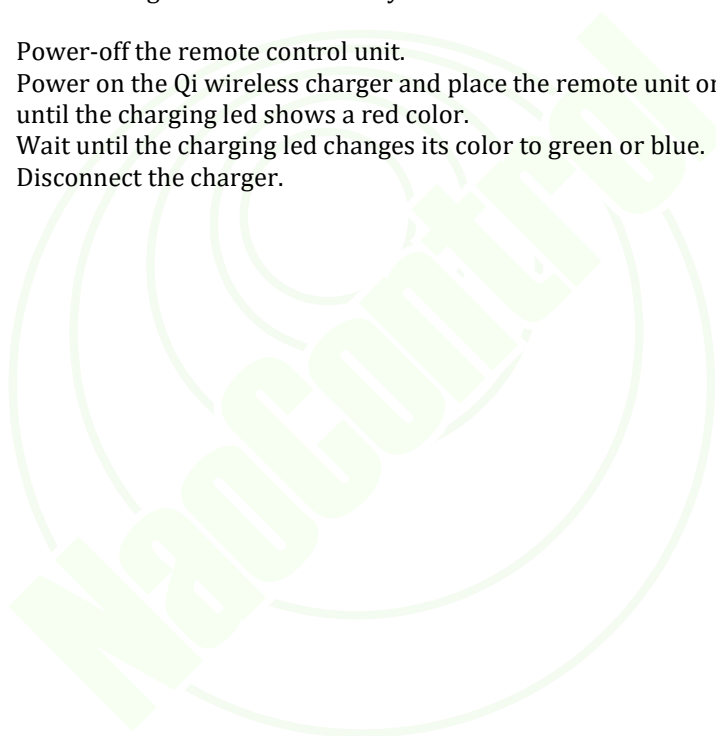
1. Power-off the remote control unit.
  2. Power on the Qi wireless charger and place the remote unit on top of it, adjusting the remote unit position until the charging led shows a red color.
  3. Wait until the charging led changes its color to green or blue.
  4. Disconnect the charger.
- 

---

## 5 Technical Information

### 5.1 General

Dimensions: 125mm x 79mm x 40mm  
Weight: 159gr.  
Operating temperature range: 0°C ~45°C  
IP rating: IP65

### 5.2 Electrical

Power source: Internal Lithium Polymer 3.7V rechargeable battery with protective circuit.  
Charging method: Internal Qi wireless charging receiver.

### 5.3 Radio subsystem

Type: Bidirectional wireless data link  
RF Band: ISM 2.4GHz  
Max TX power: 10mW ERP  
Modulation Technique: DSSS + Offset QPSK  
Range: < 500m Outdoor/Line of Sight  
< 80m Indoor  
MAC protocol IEEE 802.15.4  
Addressing: 64-bit  
Data encryption: AES, 128 bits.  
Approvals: CE (ETSI), FCC, C-TICK, IC, Telec.

## 6 Troubleshooting. Warning and error messages

### 6.1 Warning messages

Message	Meaning. <i>Suggested actions.</i>
REJECTED BY THE NETWORK	<ul style="list-style-type: none"> <li>• Other remote has been registered to the Shipcontroller network. (Only one remote can be active at a given time).</li> <li>• <i>Power off the other remote.</i></li> </ul>
NO RADIO LINK	<ul style="list-style-type: none"> <li>• The radio link between the remote and the base network cannot be established. The Shipcontroller system is off or faulty. The remote is too far from the base system.</li> <li>• <i>Check that the Shipcontroller system is powered. Check the radio coverage.</i></li> </ul>
NO ENGINE CONTROL	<ul style="list-style-type: none"> <li>• You do not get engine control when you try to use the engine buttons or levers.</li> <li>• <i>Check the status of the ship's electronic control system. Check the engine control activation procedure for Shipcontroller.</i></li> </ul>
THRUSTER LOCKED BY SPEED	<ul style="list-style-type: none"> <li>• The boat's speed is greater than the locking speed limit; the thruster control has been disabled on the remote.</li> <li>• <i>Decrease the boat's speed.</i></li> <li>• <i>Check the locking speed setting on the remote.</i></li> </ul>
WINDLASS LOCKED BY SPEED	<ul style="list-style-type: none"> <li>• The boat's speed is greater than the locking speed limit; the windlass control has been disabled on the remote.</li> <li>• <i>Decrease the boat speed.</i></li> <li>• <i>Check the locking speed setting on the remote.</i></li> </ul>

### 6.2 Error messages

Error message	Meaning. <i>Suggested actions.</i>
BATTERY EMPTY	<ul style="list-style-type: none"> <li>• The battery is empty. The remote cannot be used.</li> <li>• <i>Recharge the battery. Remember to keep the battery charged!</i></li> </ul>
RADIO MODULE ERROR	<ul style="list-style-type: none"> <li>• An error in the radio subsystem has been detected.</li> <li>• <i>Power off the whole Shipcontroller system. Power off the remote. Wait 20 seconds. Power on the remote before powering on the base system.</i></li> <li>• <i>Contact your service representative.</i></li> </ul>
RADIO CONFIG ERROR	<ul style="list-style-type: none"> <li>• An error in the radio subsystem configuration has been detected.</li> <li>• <i>Power off the whole Shipcontroller system. Power off the remote. Wait 20 seconds. Power on the remote before powering on the base system.</i></li> <li>• <i>Contact your service representative.</i></li> </ul>
PUSHBUTTON SWITCH ERROR	<ul style="list-style-type: none"> <li>• There is a problem with the membrane keyboard.</li> <li>• <i>Turn off the remote control and turn it on again, taking care not to press any button or lever.</i></li> <li>• <i>If the problem persists, contact the technical service.</i></li> </ul>
TOGGLE SWITCH ERROR	<ul style="list-style-type: none"> <li>• There is a problem with the toggle switches.</li> <li>• <i>Turn off the remote control and turn it on again, taking care not to press any button or lever.</i></li> <li>• <i>If the problem persists, contact the technical service.</i></li> </ul>
START PROCEDURE FAILED	<ul style="list-style-type: none"> <li>• The two-phase power-on protocol has not been fulfilled.</li> <li>• <i>Turn on the remote control again and remember to press (SC) when prompted.</i></li> <li>• <i>If you do not want to use the secure power-on protocol, change the configuration (Section 4.3.5).</i></li> </ul>

## 6.3 Other issues

Symptom	Meaning. <i>Suggested actions.</i>
When turning the remote on, red and green indicators blink a few times, and then both turn off.	<ul style="list-style-type: none"> <li>• The diagnostic system has detected a fault in the remote control.</li> <li>• Contact your service representative.</li> </ul>
Remote control unit will not turn on.	<ul style="list-style-type: none"> <li>• Exhausted battery.</li> <li>• System Damage.</li> <li>• <i>Charge the battery.</i></li> <li>• <i>Contact your service representative.</i></li> </ul>

## 7 Maintenance Information

### EVERY YEAR:

- Inspect the wiring, connections, and components of the Shipcontroller system.

### EVERY TWO YEARS:

- Inspect the wiring and connections of the Shipcontroller system thoroughly.
- Request a technical review that includes opening the remote control and the different modules of the Shipcontroller system to verify the tightening and good condition of the connections, components and circuit boards.
- Check the calibration of the engine control interface (in analog control systems).

## 8 Warranty Information

Naocontrol, S.L., henceforth referred to as "The Manufacturer," warrants that the Shipcontroller system is free from defects in materials and workmanship for a period of 3 years from the actual purchase date, as indicated on the purchase invoice.

### Warranty Coverage:

The Warranty, at the Manufacturer's discretion, is limited to the repair or replacement of damaged components.

### Exclusions from Warranty:

- Transportation costs for damaged or repaired parts.
- Costs for diagnostics, deinstallation, installation, or adjustment of the Shipcontroller system or any associated systems.
- Damage, malfunctions, or losses due to abuse, negligence, improper installation, repair, or maintenance; unauthorized alterations or modifications, errors in following manual instructions and warnings, use beyond operational ranges, or any other abnormal, excessive, or improper usage.
- Damage, malfunctions, or losses caused by accidents, natural disasters, force majeure, or water damage due to improper use.
- Damage or losses from the inability to use the product, associated systems, or the vessel where the product is installed.

### Warranty Claim Procedure:

- To claim the Shipcontroller warranty, the system's identification number from the documentation or a copy of the purchase invoice is required.
- Processing the warranty through an authorized Shipcontroller installer or distributor is recommended. Alternatively, claims can be made directly with the manufacturer via email at [info@shipcontroller.com](mailto:info@shipcontroller.com) for warranty assistance.



## APPENDIX I: Release notes

**Manual version: SCR756JY-v3.11**

**Firmware release: SCR756JY-v3.0**

- 3.11
  - Important information (page 2) added.
  - Warranty information updated.
- 3.0
  - The remote's welcome screen now shows the battery charge level.
  - The DPS monitor screen shows an arrow from the center with the drift direction, when the error is greater than 75cm.
  - Added new features and settings for thrusters: Thruster Balance and Thruster Minimum Thrust for Joystick X-Axis.
  - Added support to correct the position of the smart antenna of the DPS system. New settings: DPS Antenna Offset.
  - The DPS system activation/deactivation procedure has been simplified. DPS mode selection screen has been removed. (The DPS mode will be recorded in the DPU firmware).
  - The settings screen flowchart has changed to accommodate the new settings.





[www.SHIPCONTROLLER.com](http://www.SHIPCONTROLLER.com)



[www.NAOCONTROL.com](http://www.NAOCONTROL.com)